

Pluggable Multi-Pole SPD for DC Systems

SafeTec T2-1000DC-3+0(-R)

Type 2 • Type 4CA



Location of Use: DC Systems, EV Chargers
 Mode of Protection: (+)-GND, (-)-GND, (+)-(-)
 EN/UL Category: Type 2 / Type 4CA
 Technology: Hybrid
 Leakage Current Free: Yes
 Housing: Pluggable Design
 Safety: Patented Current Limiting
 Compliance: UL 1449 4th Edition

Technical Data

SafeTec T2-1000DC-3+0(-R)

1000

EN Electrical

Nominal DC Voltage	U_n	900 V
Maximum Continuous Operating Voltage (DC)	(+)-(-) U_{CDC}	1000 V
	(+/-)-G U_{CDC}	500 V
Nominal Discharge Current (8/20 μ s)	I_n	20 kA
Total Discharge Current	I_{Total}	65 kA
Voltage Protection Level	(+/-)-G U_p	2500 V
	(+)-(-) U_p	4800 V
Response Time	(+/-)-G t_A	< 100 ns
	(+)-(-) t_A	< 25 ns
Number of Ports		1

UL Electrical

Maximum Permitted DC Voltage	V_{dcmcov}	1000 V
Measured Limiting Voltage	(+/-)-G MLV	2470 V
	(+)-(-) MLV	4590 V
Nominal Discharge Current (8/20 μ s)	I_n	20 kA

Mechanical & Environmental

Operating Temperature Range	T_a	-40 °F to +185 °F [-40 °C to +85 °C]
Permissible Operating Humidity	RH	5%...95%
Altitude (max)		13123 ft [4000m]
Terminal Screw Torque	M_{max}	39.9 lbf-in [4.5 Nm]
Conductor Cross Section (max)		2 AWG (Solid, Stranded) / 4 AWG (Flexible)
		35 mm ² (Solid, Stranded) / 25 mm ² (Flexible)
Mounting		35 mm DIN Rail, EN 60715
Degree of Protection		IP 20 (built-in)
Housing Material		Thermoplastic: Extinguishing Degree UL 94 V-0
Thermal Protection		Yes
Operating State / Fault Indication		Green Flag / Not Green Flag
Remote Contacts (RC)		Optional
RC Switching Capacity		AC: 250V/1A, 125V/1A; DC: 48V/0.5A, 24V/0.5A, 12V/0.5A
RC Conductor Cross Section (max)		16 AWG (Solid) / 1.5 mm ² (Solid)





Order Information

Order Code	1000
SafeTec T2-1000DC-3+0	59.0373
SafeTec T2-1000DC-3+0-R (with remote contacts)	59.0374

SafeTec T2-1000DC-3+0(-R)

Internal Configuration

Legend

-  PE/G Conductor Terminal
-  RC Remote Contacts Terminal (Optional)
-  TC Thermal Control Function
-  TD Thermal Disconnecter

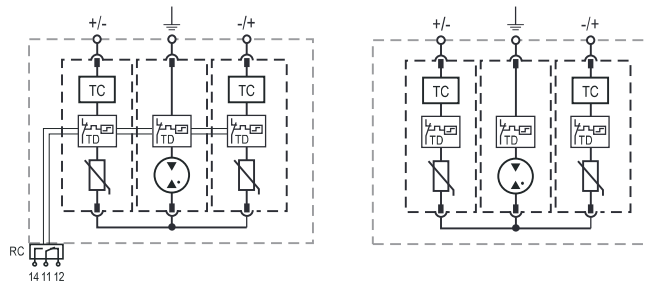

Complete Unit

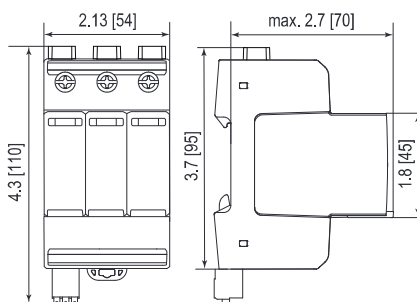

Complete Unit Dimensions & Packaging

SafeTec T2-1000DC-3+0		1000
Weight	pounds	.853
	grams	387
SafeTec T2-1000DC-3+0-R		
Weight	pounds	.870
	grams	395
DIN 43880 Dimension		3 TE / 2.13" [54]
Packaging Dimensions (HxWxL)		4.3 x 4.5 x 13.8" [109 x 115 x 352 mm]
Standard Order Quantity		5 Units

Plug Internal Configuration

SafeTec T2-xxxxDC-P

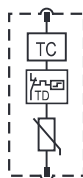

SafeTube T2-DC-P



inches
[mm]